

A landscape photograph showing a green field in the foreground, a line of trees in the middle ground, and a clear blue sky with a bright sun setting on the horizon. Several high-voltage power lines stretch across the sky from a pylon on the left towards the right.

Assumptions on demand side response and flexibility options

Brussels 9.10. PAC 2nd scenario workshop **Holger Loew**

Motivation

- Lack of holistic studies

Overview

Bringing light to the dens fog of flexibility

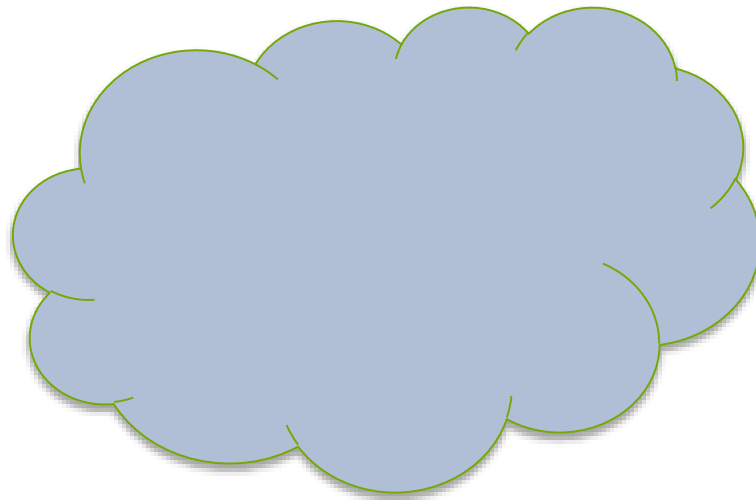

What do we already know ?

What do we already know ?

- Systems facts
 - From systems side
- Technical potential
 - From pilot projects
- Changes forced by digitalization
 - What IT technology already dose

The five dimensions of flexibility



Voltage level

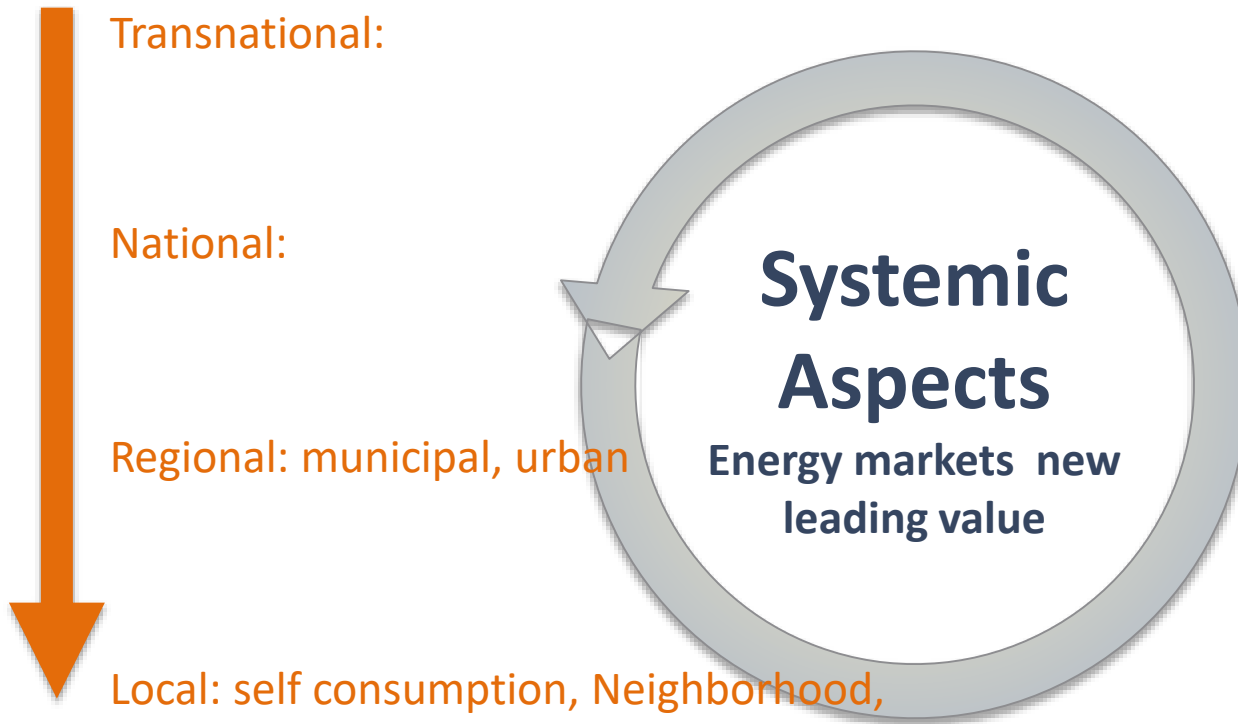

Voltage level

Transnational:

National:

Regional: municipal, urban

Local: self consumption, Neighborhood,



Time value



Short / middle term, seasonal capacity

Voltage level

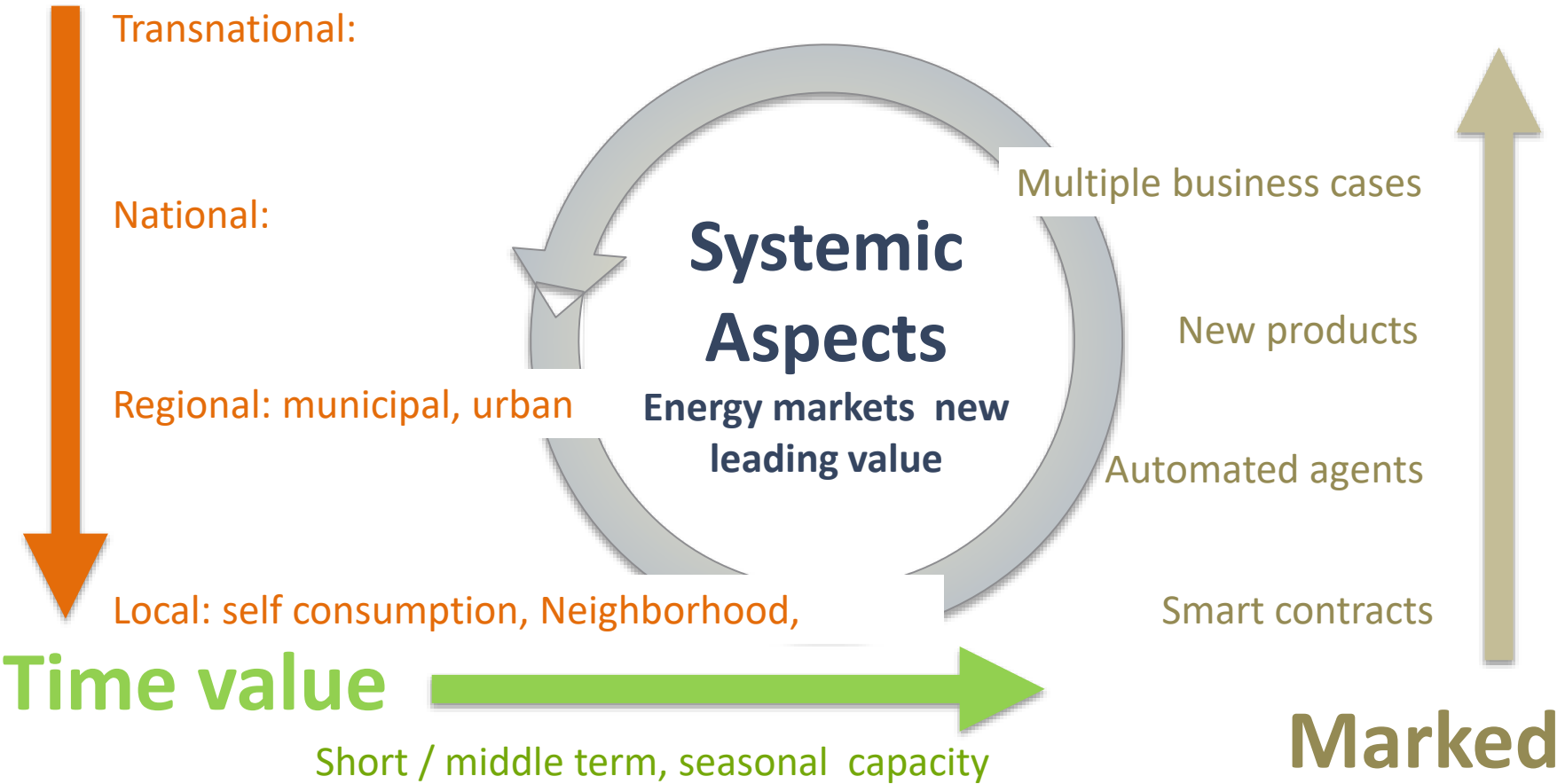

Voltage level

Transnational:

National:

Regional: municipal, urban

Local: self consumption, Neighborhood,

Time value

Short / middle term, seasonal capacity

small transaction, Fast communication
Automated control

Digitalization



Multiple business cases

New products

Automated agents

Smart contracts

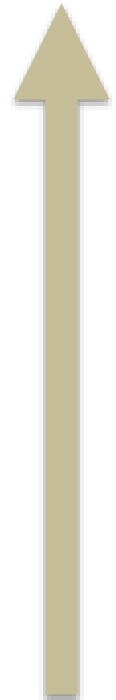

Marked



Wind & PV regional feed in curve

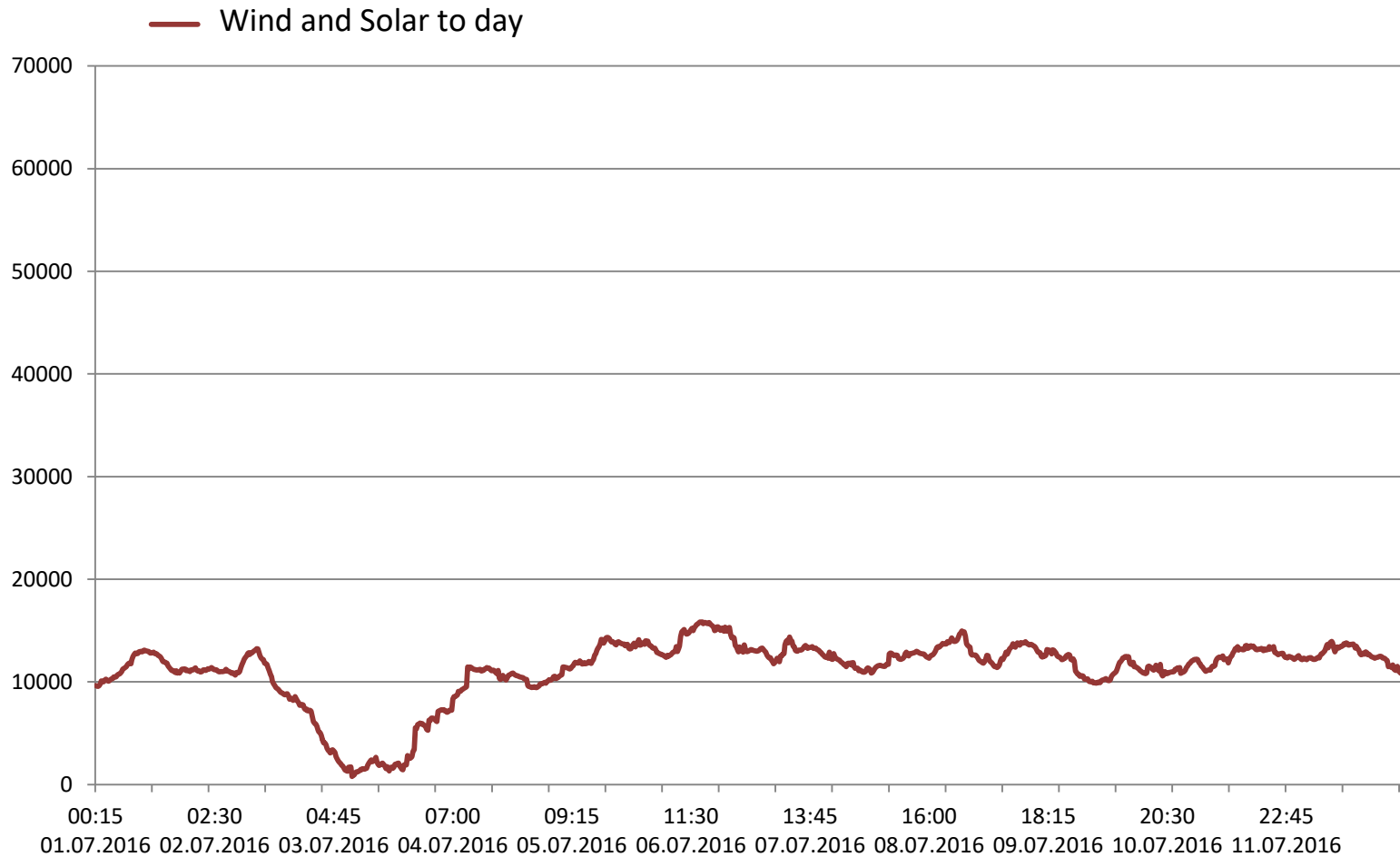

Growth of RES

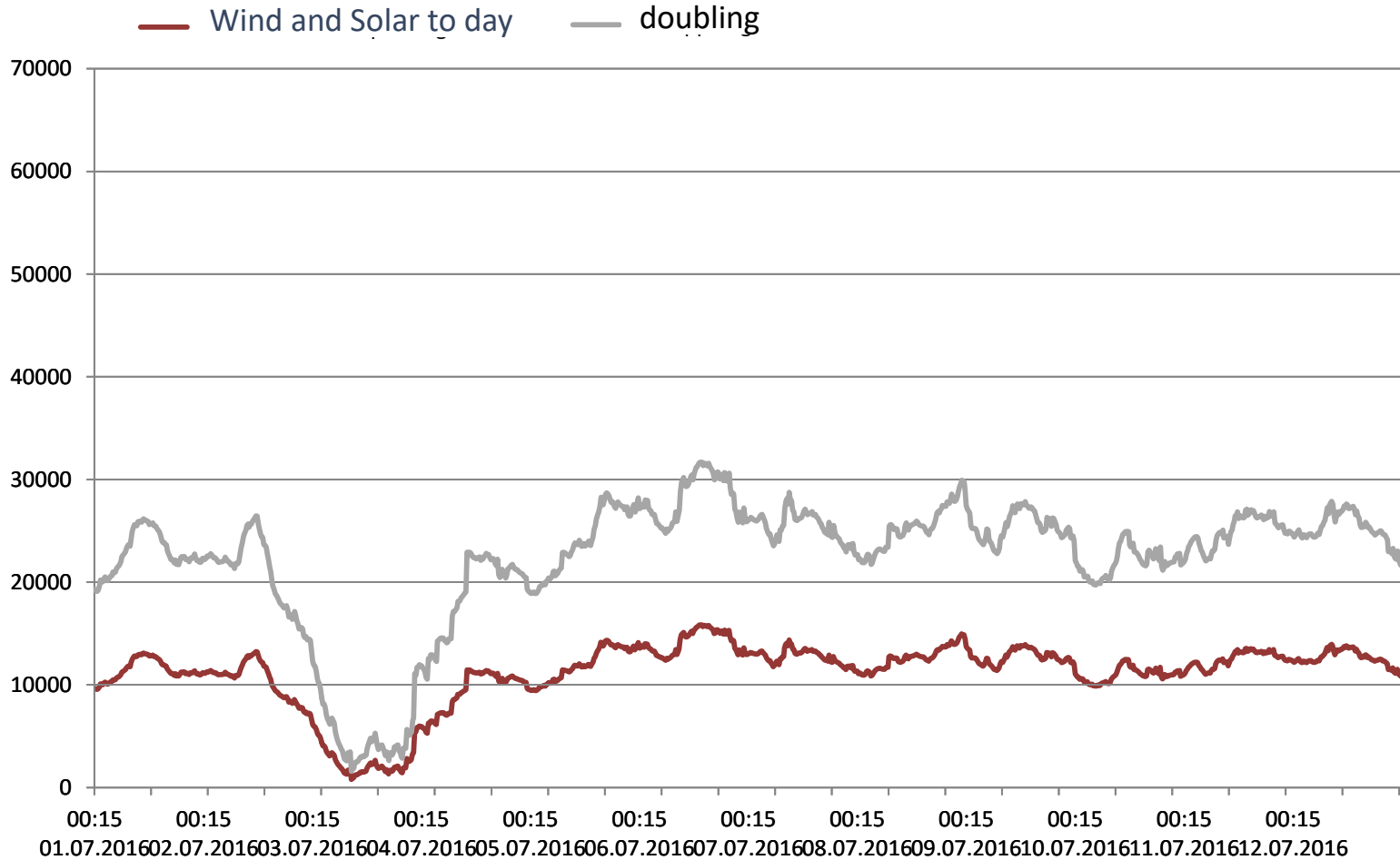

Quelle: Eigene Grafik

The system changes

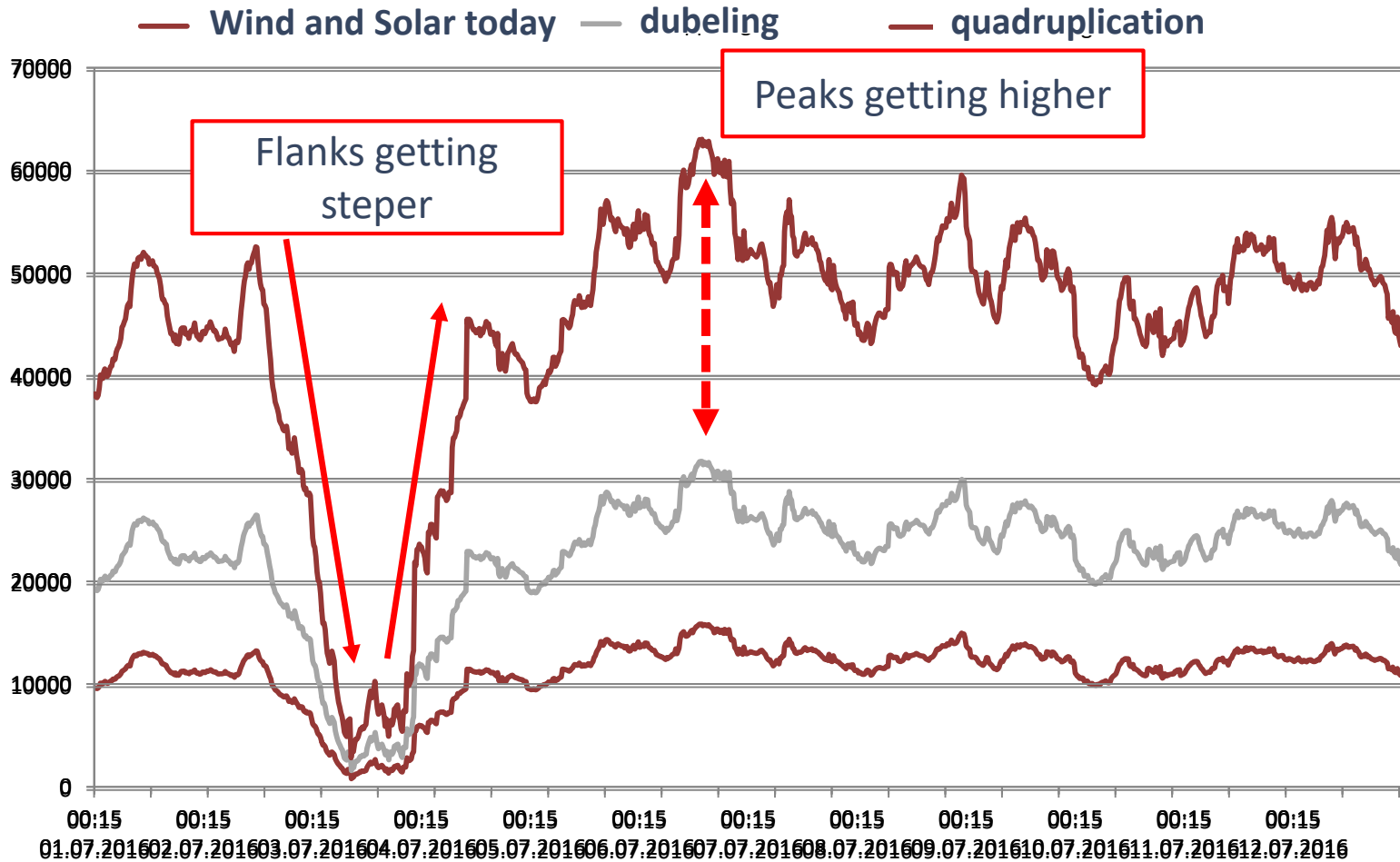

Quelle: Eigene Grafik

The system changes

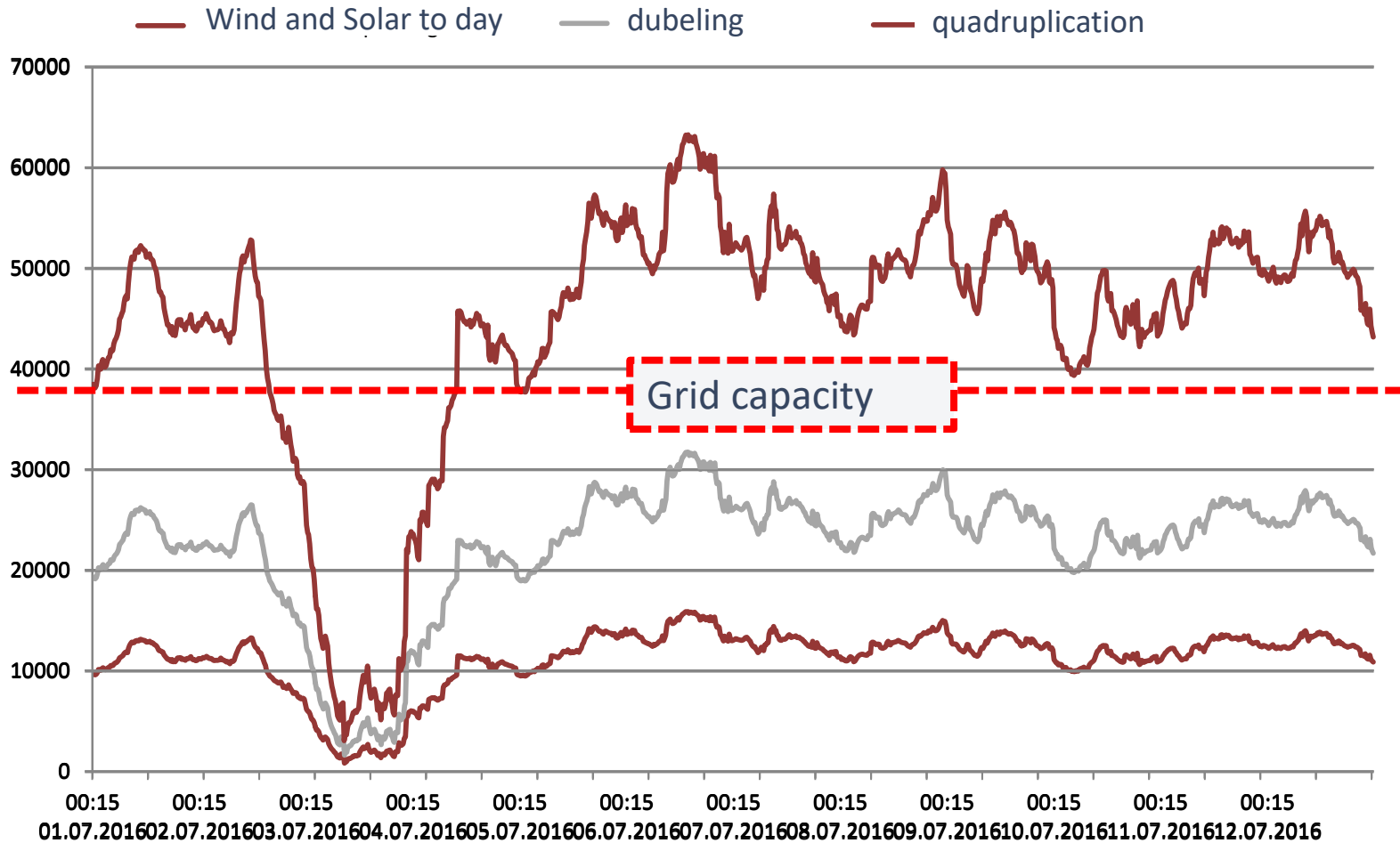

Quelle: Eigene Grafik

The system changes

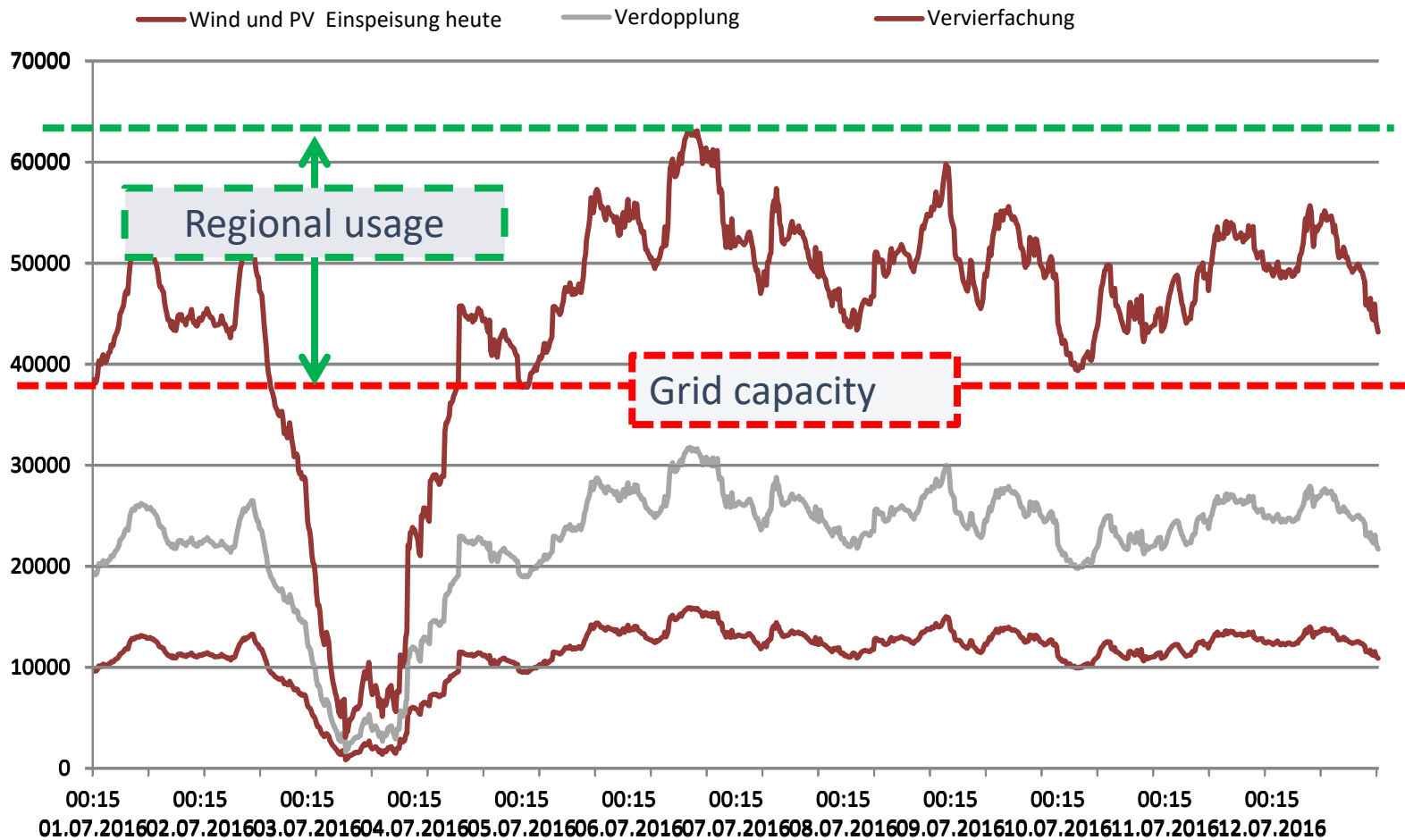

Quelle: Eigene Grafik

The system changes

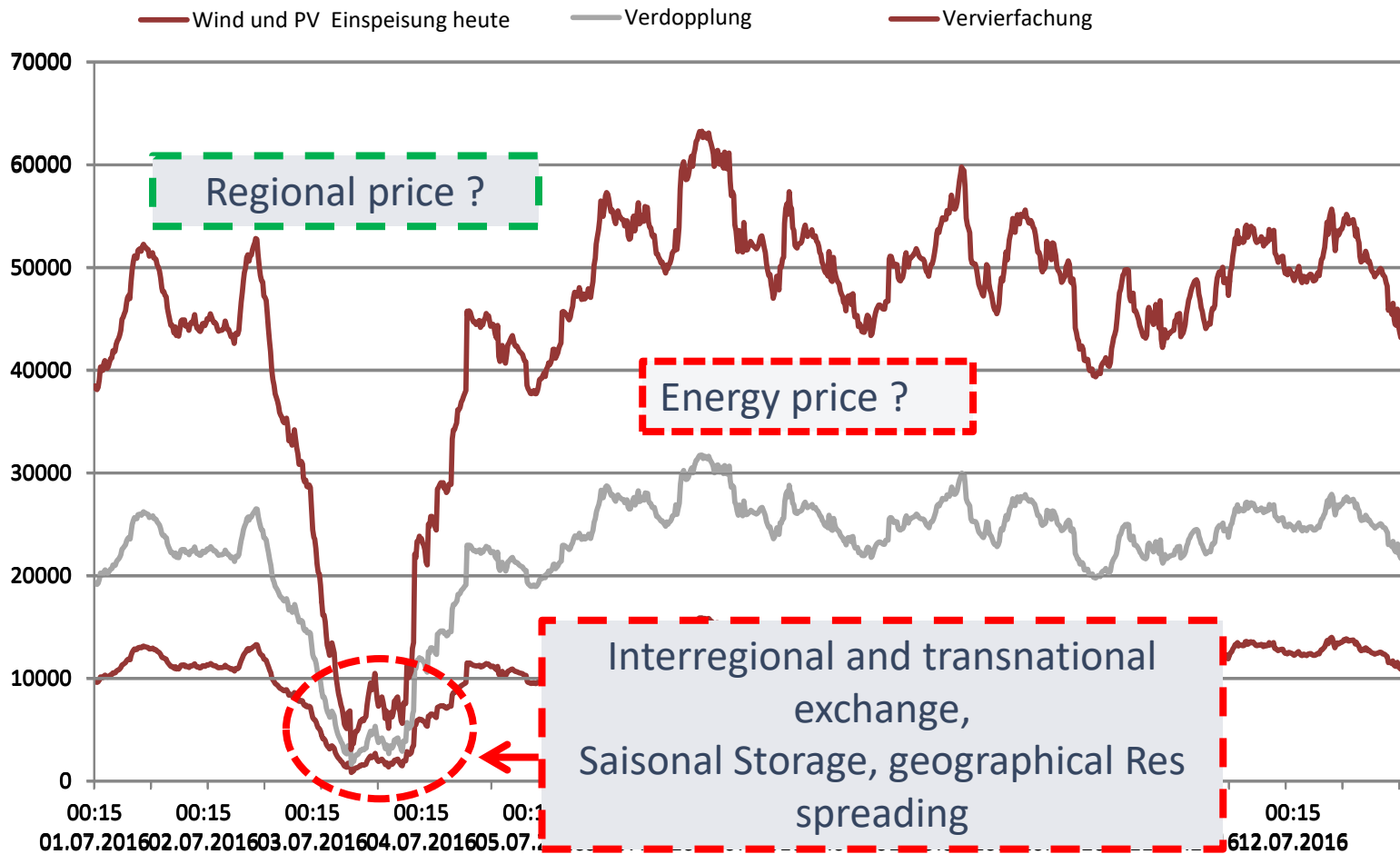

Quelle: Eigene Grafik

Voltage level

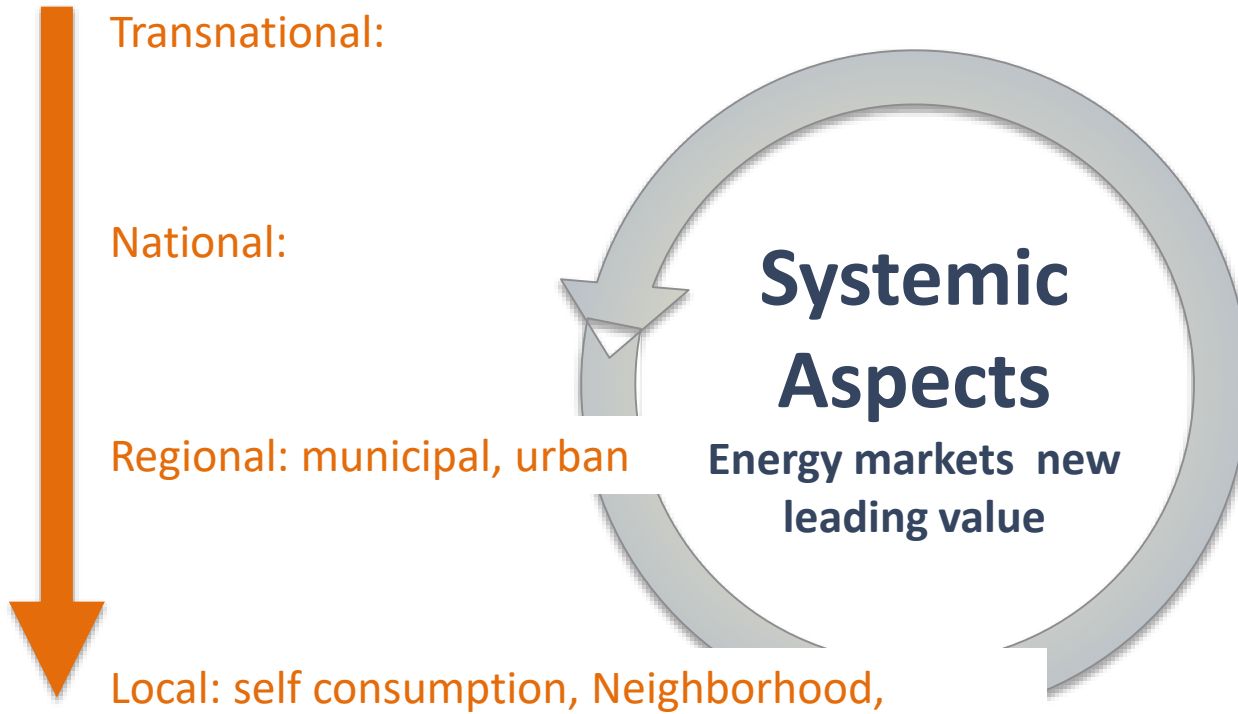

Voltage Level

- High shares of self consumption / neighborhood optimization
- Municipal cooperation/ sector coupling/ adaption to local situation, seasonal cool/ heat storage
- National compensation of different weather conditions, seasonal storages
- Transnational compensation of different geographical /weather conditions,

Flexibility Vertical dimension

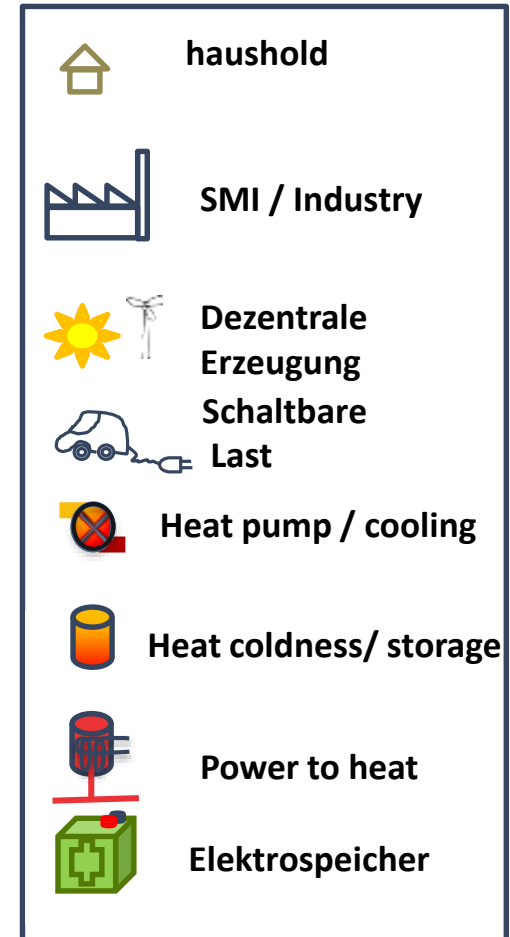
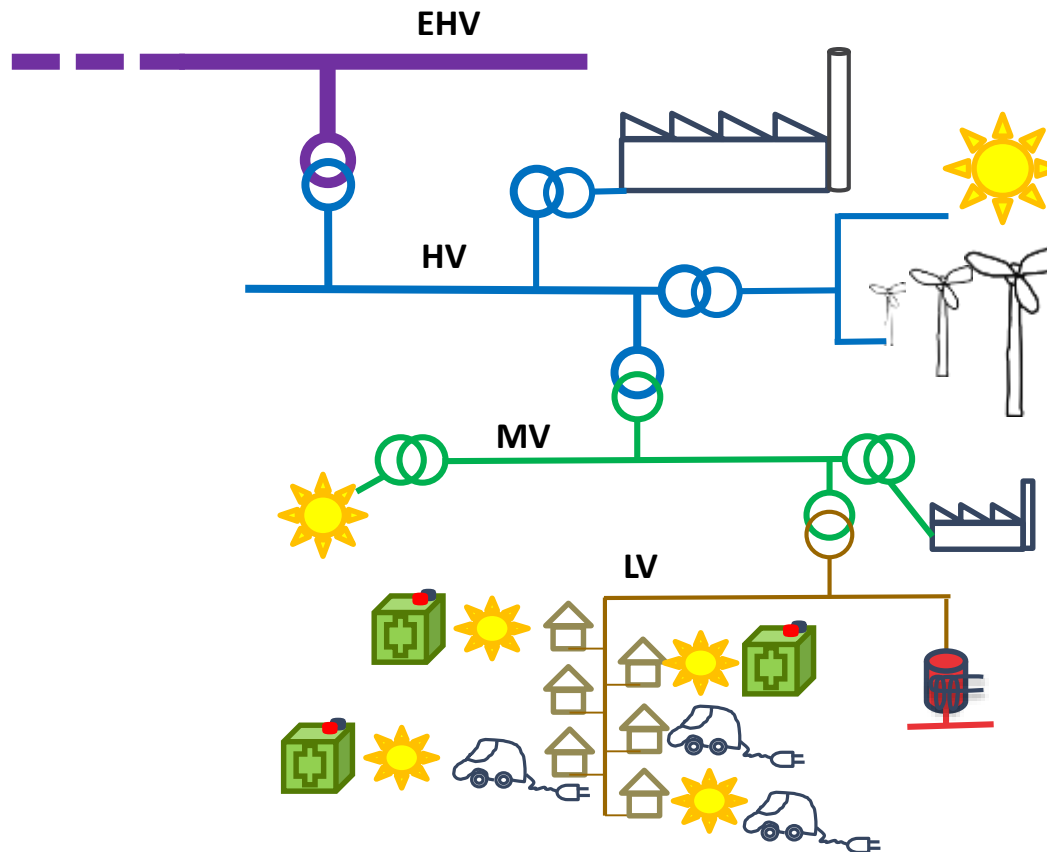

Voltage level

Transnational:

National:

Regional: municipal, urban

Local: self consumption, Neighborhood,



Time value



Short / middle term, seasonal capacity

Three Aspektes of time

- Storage capacity minutes, hours, days, seasonal
- Reaction time (msec, sec, minutes)
- Economic load cycle Minimum (full load hours) per year

Forecast quality reaction time of flexibility products (grid operator view)

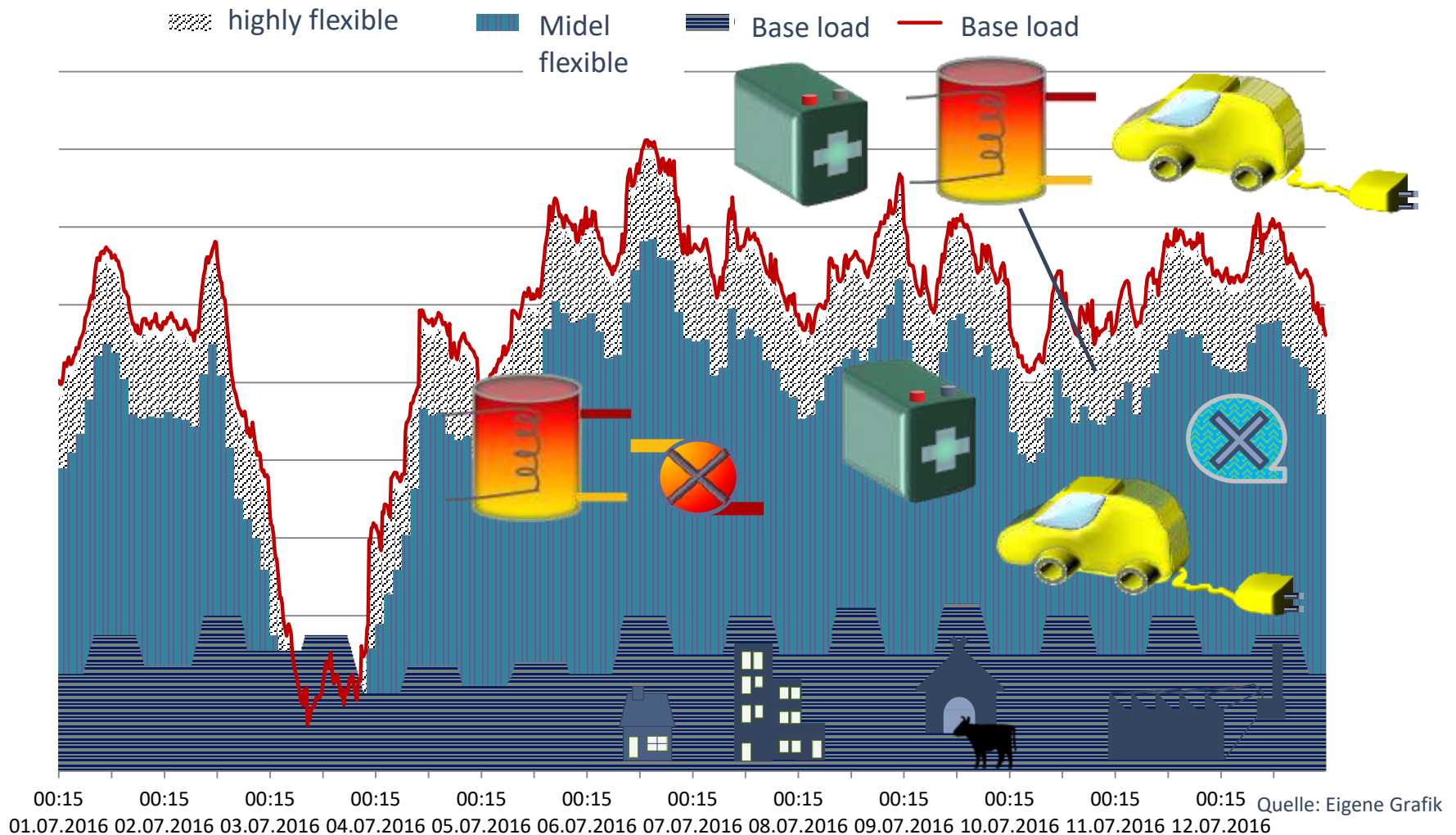

Ful lod hours investments neededs

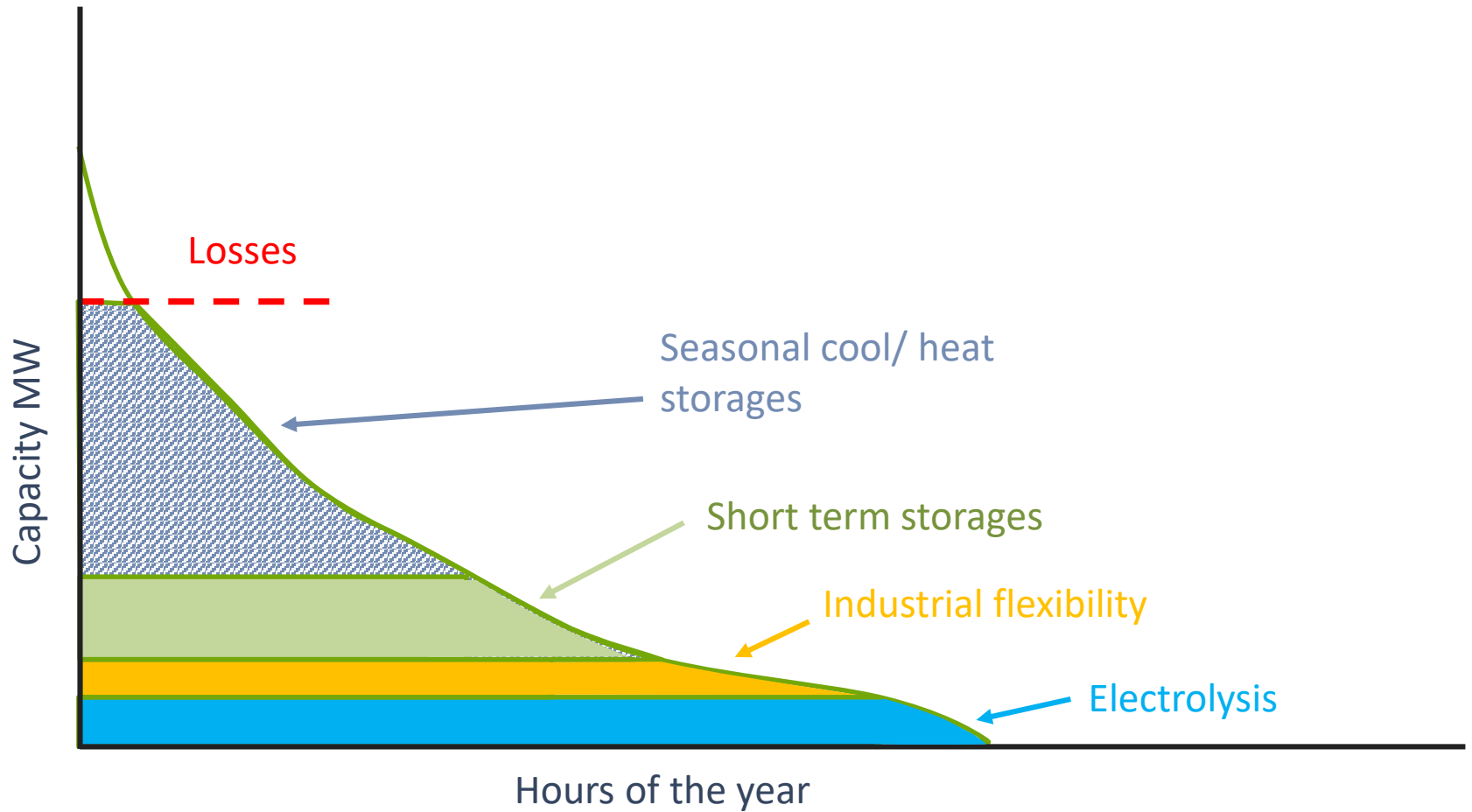

Voltage level

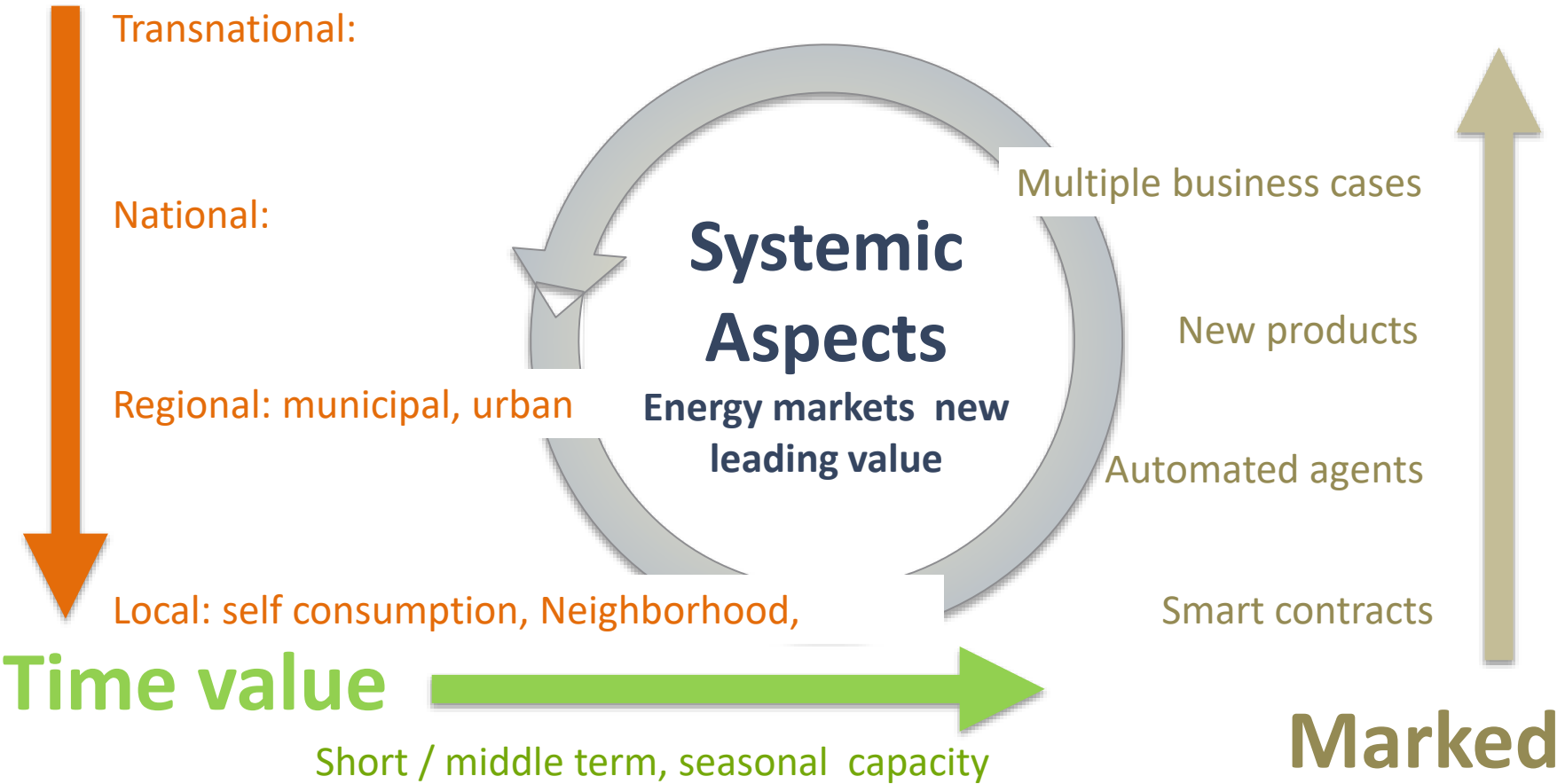

Flexibility (Market ?) aspects

**Self / community
Optimisation**

- Privat
- Comunity
- Comercial
- industrial

System optimisatzion

- Grid operator
- TSO
 - DSO

**Statutory
services**

Standardization

Flexibility Market aspects

- New products (with in 6 hours one-hour full capacity is needed, rest could be switch of)
- Multiple business cases, self consumption, price optimization, grid services, per to per, flexibility for traders ...
- Atomized personal trade agents
- Merit order of flexibility

New products

Products schedule based

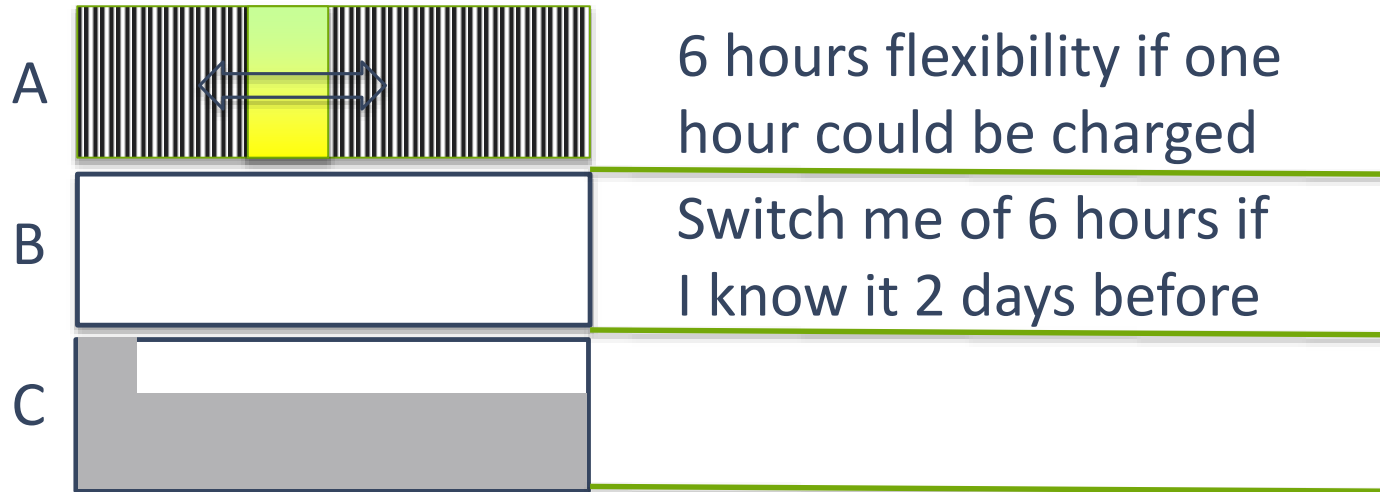

Products grid node/ Transformer based

Within the next hour we can offer 50MW consumption up down / 10 MVAR reactive power an 5 MWH black start capacity

Voltage level

Transnational:

National:

Regional: municipal, urban

Local: self consumption, Neighborhood,

Time value

Short / middle term, seasonal capacity

small transaction, Fast communication
Automated control

Digitalization



Multiple business cases

New products

Automated agents

Smart contracts

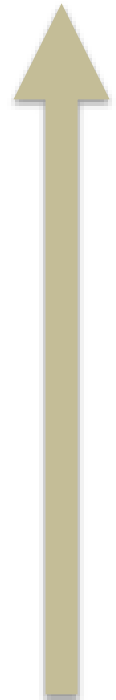

Marked

Digitalisation

- forecasts as central tools
- Small transactions getting possible
- Coordinated control of high quantity of devices
- Smart contracts, automatized private trade agents
- Peer to peer, Blockchain

Conclusions

- Flexibility is not a “ nice to have” it is the basement of a renewable dominated energy system.
- Regulatory framework, Market design and standardization must be adapted to new needs.
- Grid refinancing is a main barrier for flexibility

Thanks for
your attention

Back Up